

# UltraSecure

## PROTECT 800

### 800m Wireless Driveway Alert



## User Manual

## Your Driveway Alarm System's Receiver

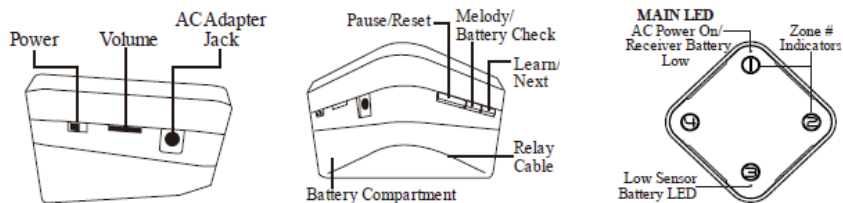

**Power:** Turns the power on or off.

**Volume:** Adjusts the Volume of the Alert Chime.

**AC Adapter Jack:** Plug in the supplied 12V/500mA adapter here.

**Pause/Reset:** To activate the PAUSE operation or to RESET. See Page 4's Helpful Tip on clearing/resetting an entire zone.

**Melody/Battery Check:** See Page 4 on choosing a melody. See Page 9 for battery check functions.

**Learn/Next:** See Page 4, Pairing your Sensors with a Receiver.

**AC Power On:** The LED above Zone 1 will turn BLUE when using AC Power.

**Battery Operate:** The LED above Zone 1 will turn RED when operating off of the 4 AA batteries.

**Receiver Battery Low:** LED above Zone 1 will flash RED every 5 sec. when receiver batteries are running low.

**Low PIR Battery LED:** LED below Zone 3 will flash RED when one or more sensor batteries are running low. See Page 9, Checking PIR Battery Strength.

## Your Driveway Alarm System's Sensor

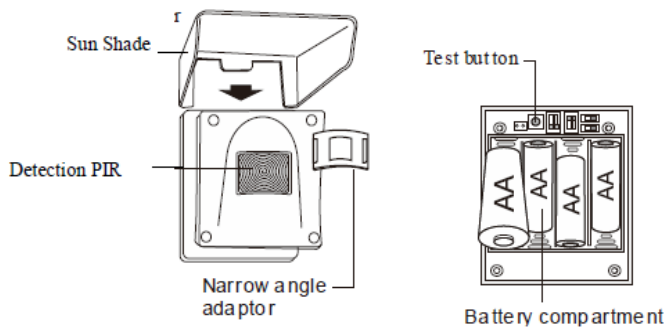

**Sun Shade:** To reduce the interference of the direct sun shine.

**Detection PIR:** Passive Infrared Detection Window

**Narrow angle adaptor:** Remove this adaptor to make wider angle.

**Test button:** Press this button to test the transmitter

## Power the system AC Adapter Information

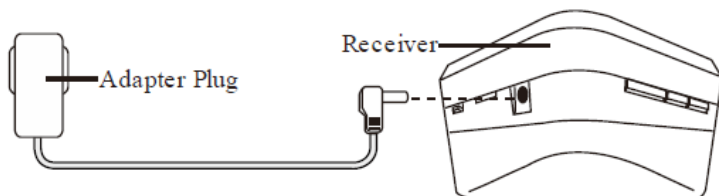

The main power source of the receiver unit is 12V/500mA AC/DC adapter.

### Installing Receiver backup Batteries

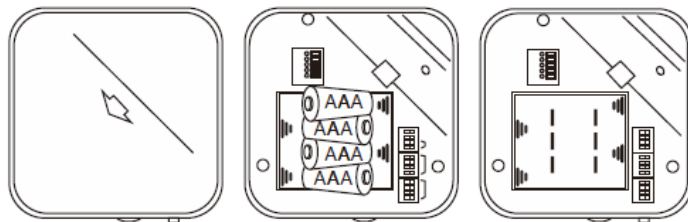

1. Slide panel to open battery compartment.
2. Install four (4) AAA batteries as indicated.
3. Replace cover.

NOTE: The receiver is equipped with a "Low Battery" alert for both the Receiver and the PIR. The alert will re-set when the low batteries are replaced.

### Powering Your Sensor

The sensor runs on four (4) AA batteries and operates wirelessly at a maximum distance of 800m from the receiver.

1. Unscrew the four cover screws and remove the cover.
2. Install four (4) AA batteries as indicated.
3. Replace the cover and secure the four screws.
4. Attach the sun shade.

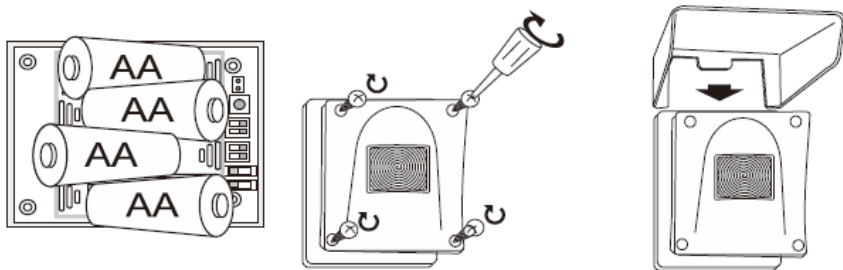

## Pairing your Sensors with a Receiver

Your sensor(s) need to be paired with a receiver before your system can be used. Follow these steps to pair sensor(s) with a receiver unit.

Press and hold "Learn" on the receiver for 3 seconds to enter Learn Mode. The Zone 1 indicator will flash.

**You have 20-30 seconds to move on to the next stage to avoid a timeout**

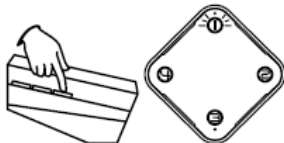

Press "Next" to light the zone indicator you wish to pair your sensor with. (If pairing Zone 1, skip this step.) Each zone's indicator will light when selected. Each zone can be paired with up to four (4) sensors. NOTE: If all spaces are occupied, all zone LEDs will flash THREE TIMES.

**You have 20-30 seconds to move on to the next stage to avoid a timeout**

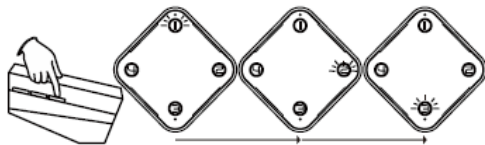

3. Keep pressing the "Melody" button to choose the melody you wish to play when the sensor is triggered.

There are a total of 32 melodies to choose from. Melody select sequence: Melody 1 > Melody 2 > ... > Melody 32 > Melody 1...

To complete the process, activate the sensor you wish to pair by slowly walking past or waving your hand at least one foot from the eye. The sensor eye will light when activated. The receiver will BEEP when successfully paired. To exit Learn Mode, press "Next" until all zone indicators turn off. (or switch the receiver off and back on again)



NOTE: If the sensor has already been paired there will be NO SOUND. The indicator of the already paired zone will flash, then the indicator of the new zone chosen in Step 2 will relight. You need to select a different zone to complete the pairing process.

Helpful Tip! Clearing All the Sensors in a Zone

1. Press and hold "Learn" for 3 seconds to enter Learn Mode.
2. Press "Next" to select which zone you wish to unpair. (If clearing Zone 1, skip this step)
3. Press and hold "Pause/Reset" for 3 seconds to unpair all the sensors in that zone. The receiver will BEEP when the zone has been unpaired.
4. Press "Next" until all indicators are off to exit Learn Mode.

## Mounting the Receiver on the Wall



Remove the original Battery Cover and replace with the wall mounting cover

Fix the wall bracket provided

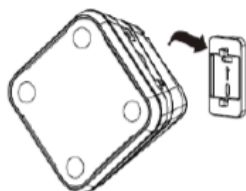
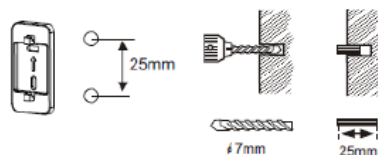

Hook the Receiver onto the wall bracket

Tap the battery cover to attach the Receiver to the wall bracket  
(Do not press the receiver body)

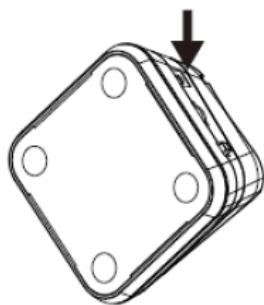

## Installing your Sensor

It is recommended that the motion sensor be mounted at least 3 feet (0.9m) from the ground on a sturdy, non-metal surface (i.e. a wall or stiff post) (as metal can interfere with wireless transmission) with the "eye" pointed toward the target sensing area.

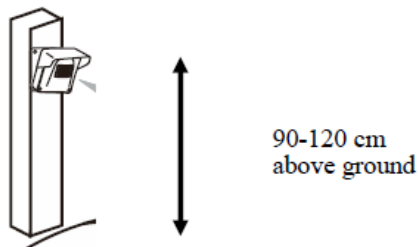

This PIR operates using an Infra-red Sensor which works by detecting sudden movements of a Heat Source (for example a person or vehicle passing through the field of view).

The PIR has a typical detection range of 15 metres (which can be reduced) for a single person passing by, this could be further if the sensor was looking towards a herd of cattle, a large vehicle or constant stream of vehicles etc).

The sensitivity of the PIR can be reduced by adjusting the 'Sensitivity' jumpers in the PIR together with the option of adjusting the filter jumpers (which changes the speed of detection), please refer to page 8 of this manual.

We also recommend installing the sensor looking away from a sudden Sun Rise or Sun Set to avoid possible false alarms.

A simple way to avoid detecting large objects or a sudden sun rise is by aiming the PIR at 45 – 60° back down the driveway (see illustration of page 7 of this manual).

It may be necessary in a few applications to aim the PIR towards the ground slightly to avoid detecting large objects in the distance, although this could then be prone to detecting large ground animals therefore we would recommend trying to change the angle of the PIR first.

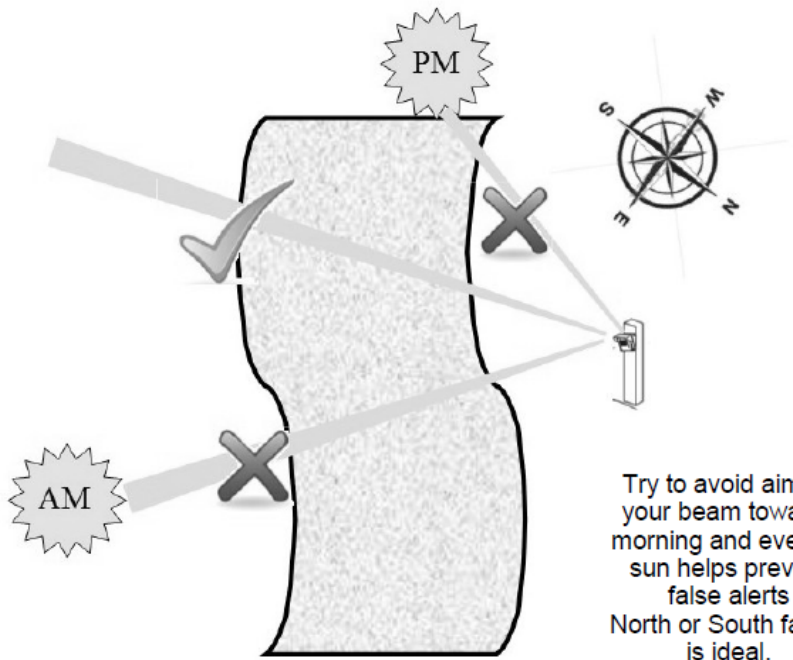

Everyone's application is different, these are the basic things to try to avoid false alerts. You will need to experiment by placing the detector in different positions to find the best solution for you, avoiding sun, cattle and passing pedestrians and traffic not on your land.

## Advanced Settings: Sensor Adjustments

Several switches are inside the battery compartment which regulate various sensor functions. Follow this guide to adjust your unit to the desired setting(s).

NOTE: Your unit is already set by the manufacturer to the most commonly used settings. Only make adjustments to these settings if the unit does not work as desired under the factory settings.

Remove the sun shade and the four screws holding the sensor cover in place.



Inside the sensor unit is a battery compartment and rows of switches which control the sensor settings. Use the guide below to set the sensor according to your preferences using a pen or other hard, narrow object to move the switches.

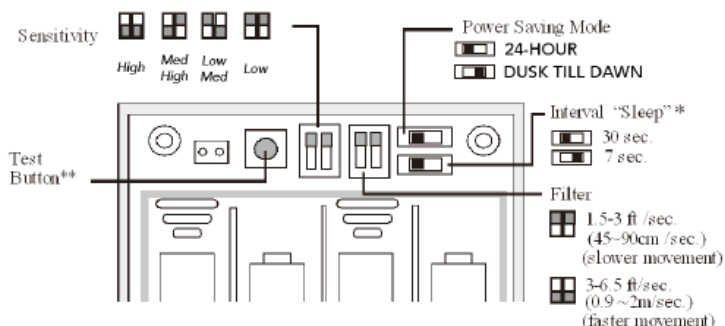

### Sensitivity Jumpers

The default sensitivity setting of the PIR is set to 'High', if you are detecting objects that you do not want to detect, please try adjusting the 'sensitivity jumpers between Low, Low/Medium. Low/High by carefully moving the switch positions (as per diagram).

### Power Saving Mode

The default setting for the Power Saving Mode is 'OFF' which gives you 24 hour operation, for applications where it would be convenient for the PIR to only work in low & dark light levels, please adjust 'Power Saving Mode' to ON. Ideal if you have a location where you just want Alerts during the night.

### Interval Sleep Time

This is the time that the PIR will be inactive after an activation, therefore 30 seconds will result in better battery life, 7 seconds will result in better protection.

### Filter

This allows you to set the PIR up to detect slower or faster movement.

\* After detecting motion, the sensor can "sleep" for either 7 or 30 seconds, allowing an object to pass through the field of vision before setting the alarm off again.

\*\*The Test Button can be pressed during set up to test that the sensor has been correctly paired with its receiver. The Test Button is also used to recode the sensor in cases where more than one receiver is being used (see Helpful Tip on Page 9).



## Checking Sensor Battery Strength

All sensor batteries should be checked frequently to prevent malfunction of the alarm system. Check the sensor batteries by using the receiver's "Battery Check" button and following the instructions below.

Press and hold "Battery Check" for 3 seconds to enter Check Mode.

The MAIN RED LED will light. (Situated below zone 3 indicator)

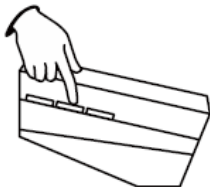

Press "Next" to select the zone you want to check. (The chosen zone LED will illuminate)

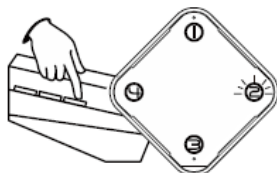

3. Press and hold "Battery Check". The illuminated zone LED will go out while you hold the button in if the batteries are good, if there is a low battery zone LED's 1 to 4 will illuminate whilst the button is held down.

If a zone LED is illuminated whilst the Battery Check button is held in, this will be indicating which PIR in the zone being checked is low (example the first PIR to be paired into a zone will be showed as zone 1, the second PIR to be paired into a zone will show as zone 2).

4. Release button. Repeat Steps 2 & 3 to check remaining zones.

### Helpful Tip! Multiple Receiver Conflicts

If you are experiencing interference, or you have multiple receivers and/or over 16

sensors, and they utilize the same signal code, you will need to manually change the code in one or more of your sensor units. To do this:

REMOVE the battery. PRESS and HOLD the button inside the sensor battery compartment before INSERT the battery again.

When the LED flash five times, a new signal code has been generated.

NOTE: The recoded sensor(s) will need to be re-paired with a receiver. See Section D for instructions.

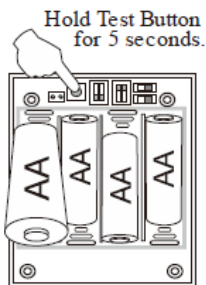

## Advanced Settings: Receiver Switches & External Devices

NOTE: Your unit has been set by the manufacturer to the most commonly used settings. It is strongly suggested that the system be used first under its factory settings before adjusting the dip switches. If you are connecting an external device to the receiver, consult with the external device's user manual for installation details and parameters.

The receiver battery cover must be removed in order to access the dip switches and output terminals (see Section E). Use a pen or other hard, narrow object to move the switches to your preferred setting.

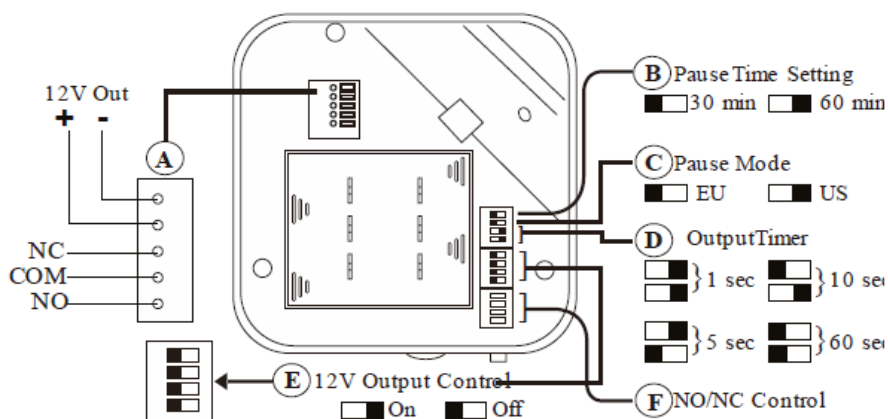

**A. Output Terminal:** External devices, such as gate openers, door releases, Sirens, Strobes or Bells, can be wired to the receiver using the 12V out relay.

- 12V Out: This terminal outputs 12V/300mA when the selected zone has been triggered in cooperation with "E" (12V Output Control). ***This function is disabled when running on batteries.*** Select which zone relays to this output by sliding ONE of the dip switches for zones 5, 6, 7, or 8 to the "On" position. ***The 12v output can be set to 1, 5, 10 or 60 seconds***

- NO (Normal Open): Outputs to a closed circuit when the selected zone has been triggered.

- COM: Neutral/Grounding terminal.

- NC (Normal Closed): Outputs to an open circuit when the selected zone has been triggered.

- The NO and NC outputs cooperate with "F" (NO/NC Control). You can select which zone relays to these outputs by sliding ONE of the dip switches 9, 10, 11, or 12 to the "On" position. ***These Relays have a Momentary action***

**B. Pause Time Setting:** Halts receiver operation for an extended time of either 30 or 60 minutes. (See Section C for instructions on pausing.)

**C. Pause Mode:** In EU Mode, the receiver will automatically turn on after the pause has timed out. In US Mode, the receiver will BEEP when the pause time is over, but will NOT automatically turn on.

**D. Output Timer Setting:** Adjusts the duration time of the 12V output duration time  
Example: If set at 1 second, the 12V output will give out a 12V for 1 Second when the sensor is triggered and the chime sounds.

**E. 12V Output Control:** Assigns a zone to the 12V Output terminal ("A") for externally wired devices. See A, Output Terminal, on Page 10 for details.

**F. NO/NC Control:** Selects which zone will connect with the NO/NC terminals.

#### **Manufacturer Default Settings**

**Listed below are the factory settings for your driveway alarm system.**

NOTE: Your system has been preset by the manufacturer to the most commonly used settings. It is recommended that users test the unit(s) under the default settings before making adjustments. If you have questions about these settings, please contact Customer Service.

#### Receiver

Pause Time	30 minutes
Pause Mode	EU
OutputTimer	1 second
12V Outputs	all OFF
NO/NC Control	all OFF

#### Sensor

Interval "leap" Timer	7 seconds
Power Saving Mode	OFF
Filter	3-6.5 ft (0.9~2m )/sec
Sensitivity	High



**Environmental Information for Customers in the European Union** European Directive 2002/96/EC requires that the equipment bearing this symbol on the product and/or its packaging must not be disposed of with unsorted municipal waste. The symbol indicates that this product should be disposed of separately from regular household waste streams. It is your responsibility to dispose of this and other electric and electronic equipment via designated collection facilities appointed by the government or local authorities. Correct disposal and recycling will help prevent potential negative consequences to the environment and human health.

For more detailed information about the disposal of your old equipment, please contact your local authorities, waste disposal service, or the shop where you purchased the product.

## **Sales & Technical Helplines**

Our Sales & Technical helplines are open  
Monday to Friday from 8.00am to 5.00pm

### **SALES**



++44 (0)1604 589414 (and press option 1)



info@ultrasecuredirect.com

### **TECHNICAL**



++44 (0)1604 589414 (and press option 2)



technical@ultrasecuredirect.com

**ULTRA SECURE LTD,**

9-10 RYEHILL COURT,

LODGE FARM I/E, NORTHAMPTON, NN5 7EU

UNITED KINGDOM

[www.ultrasecuredirect.com](http://www.ultrasecuredirect.com)