

Smart Floodlight Cam



Outdoor Light

+



Camera

Quick Installation Guide

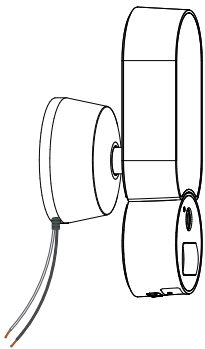

AC VERSION

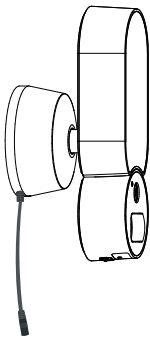

DC VERSION

1.Packing List

Open the package, then make sure the floodlight cam(device) is intact, and with all the below accessories.

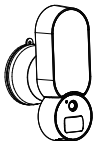

Smart Floodlight Cam.



Installation Manual

Please refer to the installation pictures in the App, and read this manual and keep it handy during installation.



Hook

Hang your Floodlight Cam while connecting the wires.



Mounting Plate

Use this plate to attach to your Floodlight Cam.



Slim Self-drilling screw (2)

Use this two screws to attach the mounting plate to the European junction box.

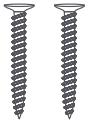

Philips big flathead self-drilling screw (4)

Use pairs of screws to attach the mounting plate to the wall or light pole.



Plastic Expansion Nails Plug (4)

Knock the plastic expansion nails plug into the hole.

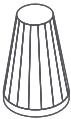

Wire Nuts (3)

Use these to connect Floodlight Cam wires to your existing wires.



Waterproof Phillips Machine Screw (3)

Use one for the earth, one for the anti-stolen hole, and one for backup.



WARNING

This manual is for information purpose only. Working with electricity can be dangerous unless proper safety precautions are taken.

If you are not comfortable or are inexperienced with the processes and tools described in this manual, we recommend that you hire a licensed electrician.

2.How it all fits together

AC Version Method One - Normally for the outdoor environment!

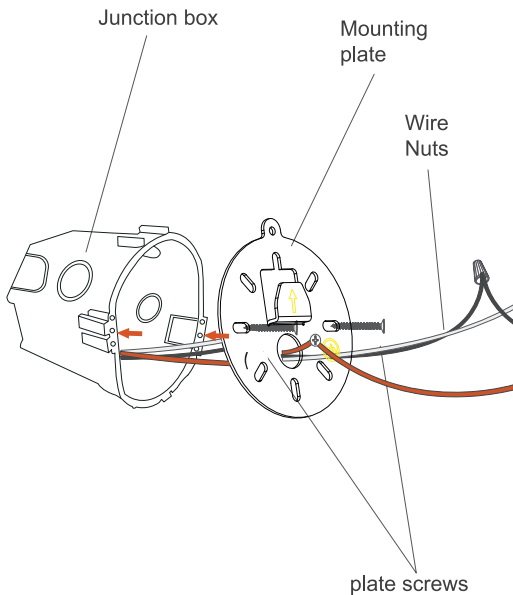

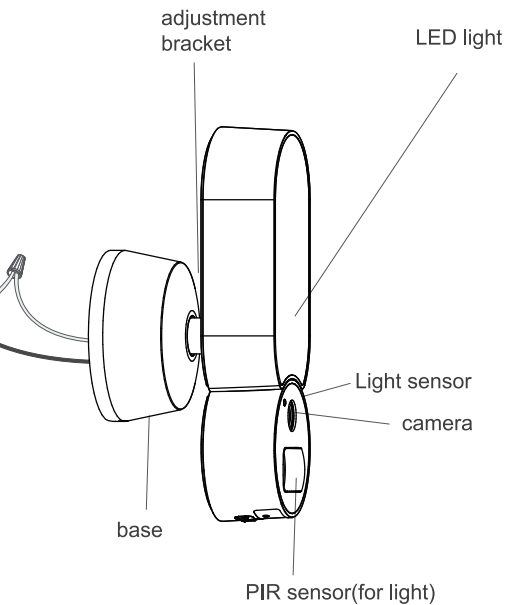

AC Version Method Two - Normally for the indoor environment

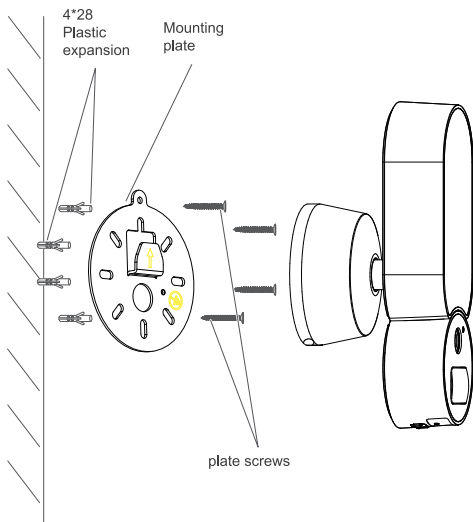

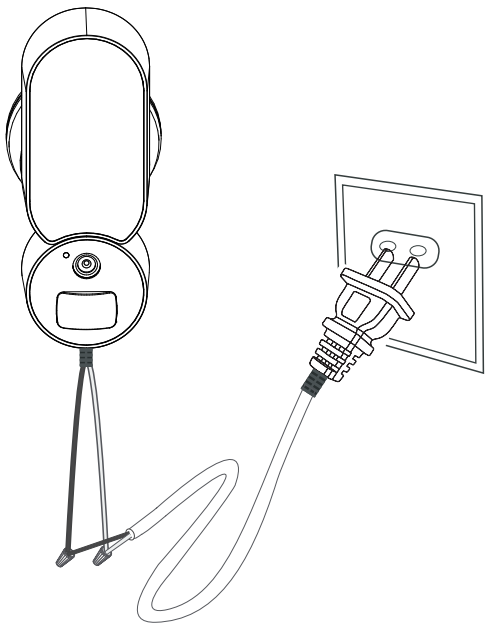

DC Version - For indoor and outdoor environment!
(Adapter with 3 meters wire)

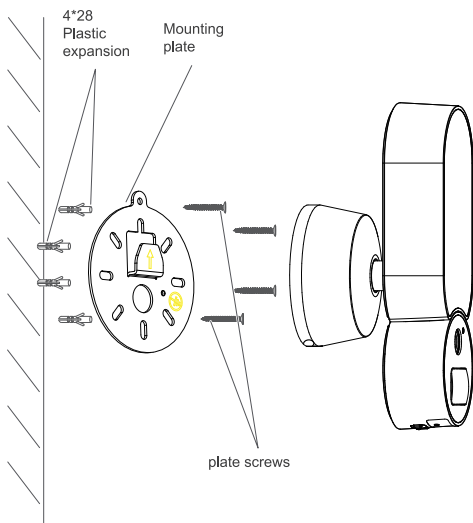

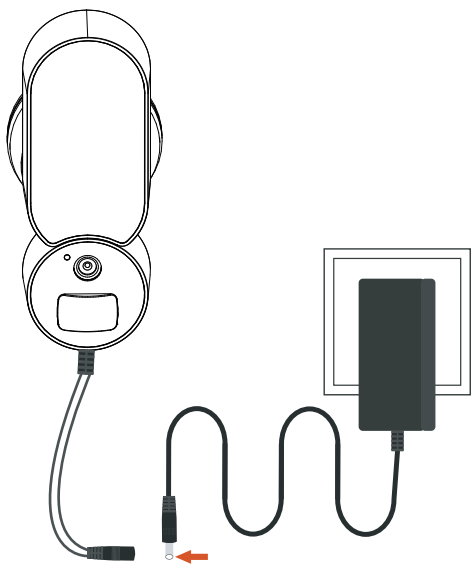

3.The proper installation height to optimize the motion sensor performance

i WARNING

In order to prolong service life of the equipment, please try to install the equipment in a place without rain and high temperature and humidity.

Parallel to ground

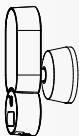

26 feet (8 Meters)

When mounted at 3 meters off the ground, with the motion detector about 30 degree to the ground, the detect human-sized objects distance up to 8 meters.

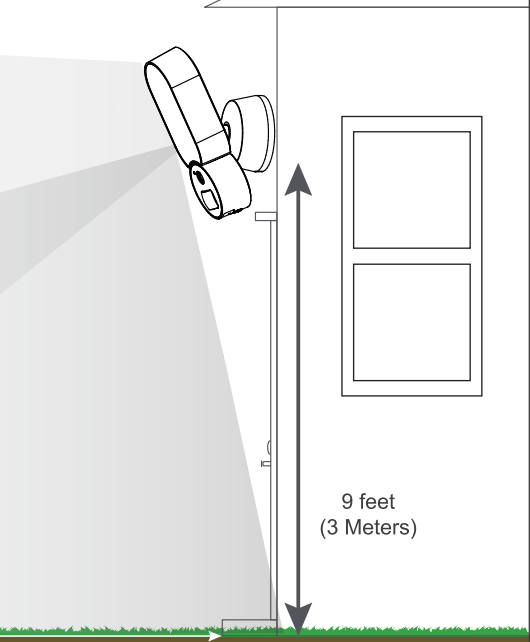

AC Version Method One

Step 1 - Shut power off at the fusebox

If you don't know where your breaker is or how to turn off power to the floodlight circuit, consult with a licensed electrician.

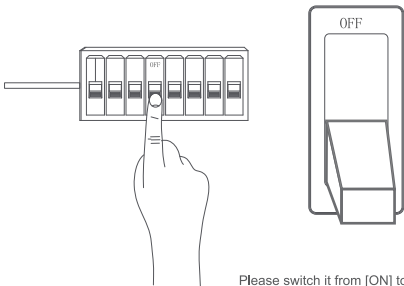

WARNING: Risk of electrical shock

- Disconnect power at the circuit breaker before installing.
 - Verify that the supply voltage is correct.
 - Connect fixture to a 110VAC ~ 240VAC 50/60 Hz power source.
-
- Properly ground fixture.
 - Always follow code standards when installing wired connections.
 - Installation and wiring must be performed by a licensed electrician.

CAUTION: Risk of fire

- Do not install near combustible or flammable surfaces.

NOTICE

- Do not connect this light fixture to a dimmer switch or timer.

Step 2 - Fixing the mounting plate to the European junction box

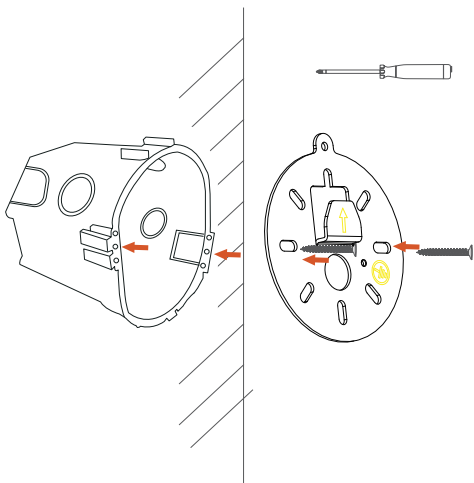

Step 3- Connect the power wire

Connect power wire to terminals Black (Live) and White (Neutral)

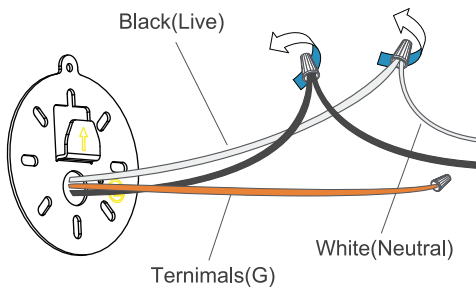

If you don't know which is neutral or hot wire coming out of the junction box, consult with a licensed electrician.

Step 4 - Push the wire nuts back to the junction box

Carefully push all the wires through the certain hole in the mounting plate.

Tighten the Phillips machine screw to the Earthhole of the mounting plate.

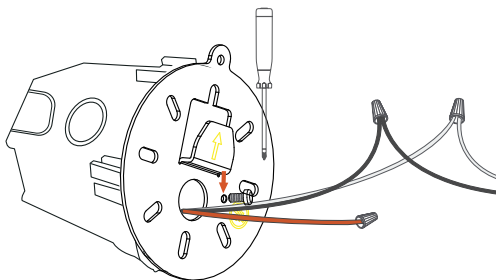

Step 5 - Hang the floodlight camera on the plate hook.

Align the iron hook and push the floodlight camera down until it's completely stable.

PUSH THE
CAMERA BASE

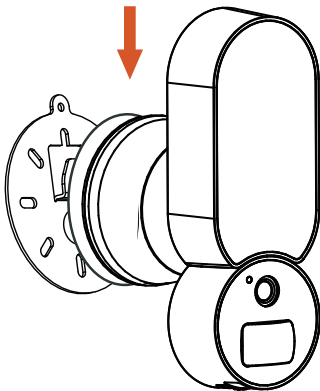

Step 6 - Tighten the Phillips machine screw to the anti-stolen hole

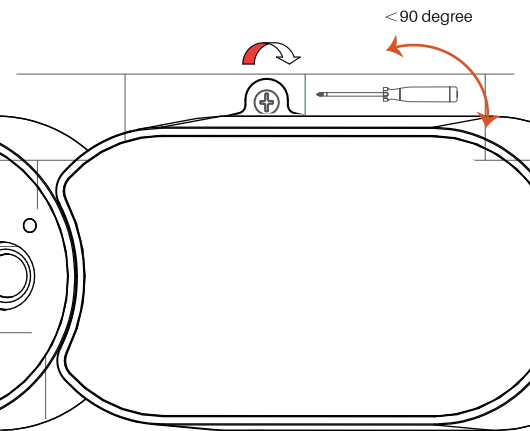

Step 7 - Adjust the floodlight to suitable angle manually

The vertical direction is 45 degree together, the horizontal direction is 30 degree together, and the overall rotation does not exceed 180 degree (counterclockwise or clockwise, one side does not exceed 90 degree).

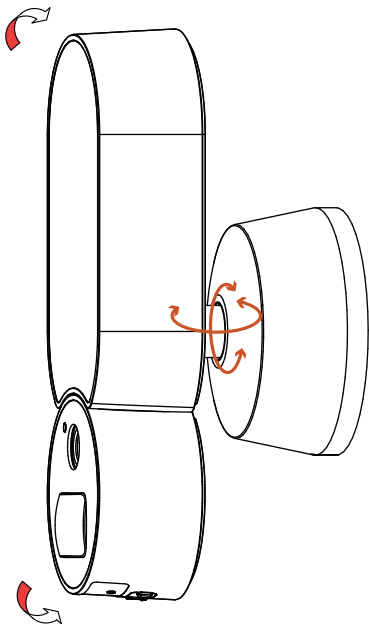

Step 8 - Restore power at the breaker

After restoring power, the lights will turn on and your Floodlight Cam will begin speaking to you to let you know it is in setup mode.

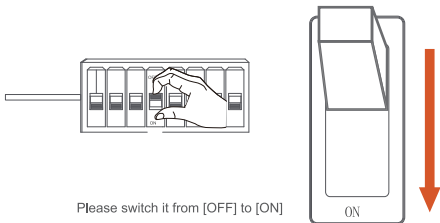

Step 9 - App setup

Open the App, follow the user manual to connect Floodlight Cam to your WiFi network.



AC Version Method Two

Step 1 - Shut power off at the fusebox

If you don't know where your breaker is or how to turn off power to the floodlight circuit, consult with a licensed electrician.

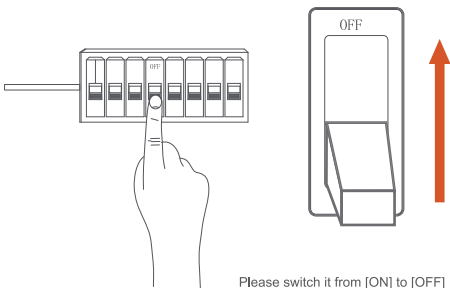

WARNING: Risk of electrical shock

- Disconnect power at the circuit breaker before installing.
- Verify that the supply voltage is correct.
- Connect fixture to a 110VAC ~ 240VAC 50/60 Hz power source.

- Properly ground fixture.
- Always follow code standards when installing wired connections.
- Installation and wiring must be performed by a licensed electrician.

CAUTION: Risk of fire

- Do not install near combustible or flammable surfaces.

NOTICE

- Do not connect this light fixture to a dimmer switch or timer.

Step 2- To determine the location

First, determine the height of the chassis, and then use the pen to draw the position of the screw hole, make a mark.

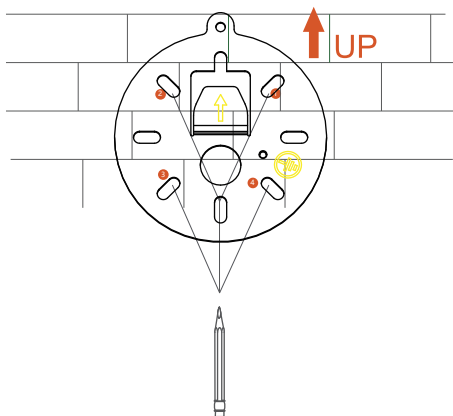

Step 3- Choose a proper place for drilling

- 1 Before drilling, ensure that the hole does not impinge on pipe work, cables or other building services.
- 2 Knock the plastic expansion nail plug into the hole.

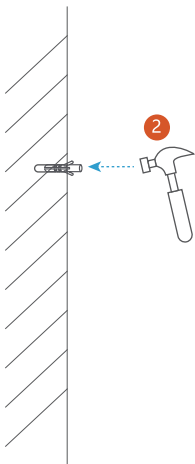
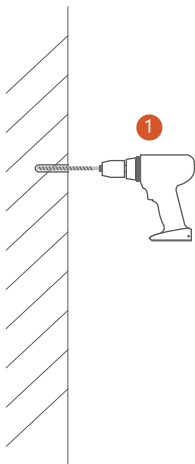

Step 4 - Fix mounting plate

Tighten the screw and fix the plate. Pay attention to the horizontal position on the top.

Tighten the Phillips machine screw to the Earth hole of the mounting plate.

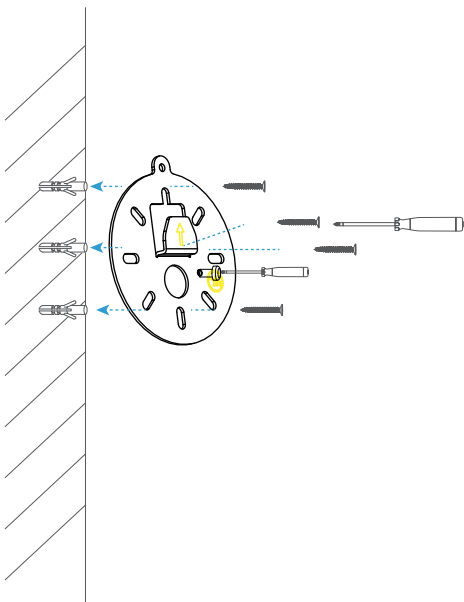

Step 5 - Hang the floodlight camera on the plate hook

Align the iron hook and push the floodlight camera down until it's completely stable.

Tighten the Phillips machine screw to the anti-stolen hole

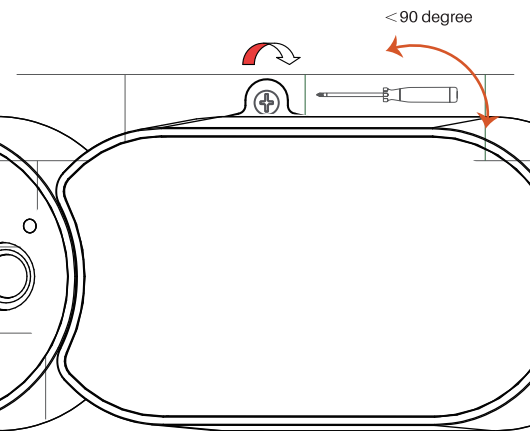

Step 6 - Connect the power wire.

Connect power wire to terminals Black(Live) and White(Neutral), then plug in the socket.

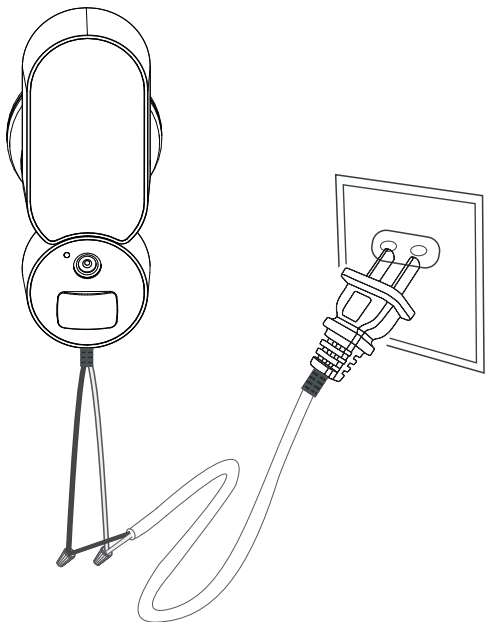

Step 7 - Adjust the floodlight to suitable angle manually

The vertical direction is 45 degree together, the horizontal direction is 30 degree together, and the overall rotation does not exceed 180 degree (counterclockwise or clockwise, one side does not exceed 90 degree).

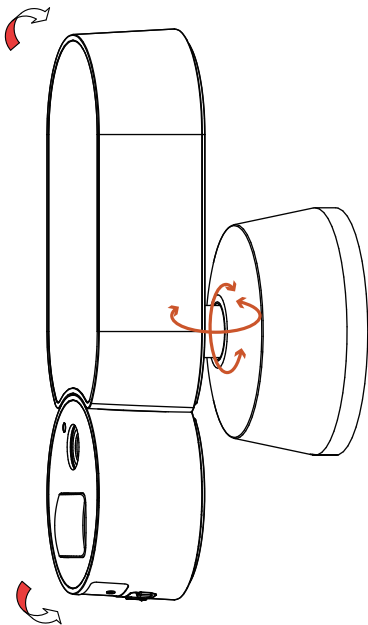

Step 8 - Restore power at the breaker

After restoring power, the lights will turn on and your Floodlight Cam will begin speaking to you to let you know it is in setup mode.

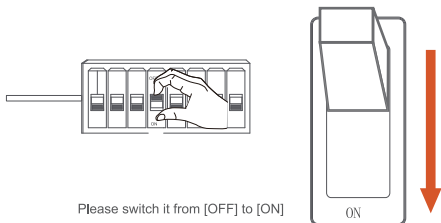

Step 9 - App setup

Open the App, follow the user manual to connect Floodlight Cam to your WiFi network.



THE DC VERSION MOUNTING WAY REFER
TO THE AC VERSION METHOD TWO!

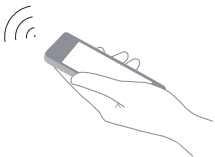
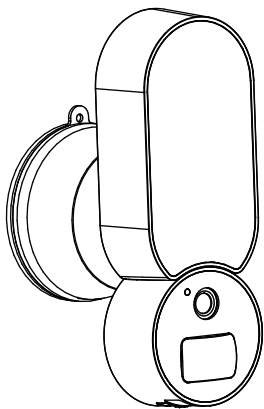

Connect Floodlight Cam to Your APP

1.Preparation

Please prepare the below stuff before you use it.

One smartphone or tablet PC(Mac or Windows PC is not acceptable) with IOS 10.0 or Android 4.4 system(higher version system is acceptable)



Android phone

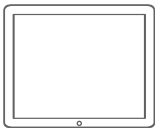

iPad



iPhone

Wi-Fi Router

- Device can only connect to 2.4Ghz Wi-Fi router.
- Make sure turn on the DHCP of router, and MAC address should be off.
- Distance between the router and the device should be within 3 meters during configuration.
- Please don't use special character such as Chinese, symbol to name the WiFi.
- Please don't use special character such as Chinese, symbol as the password, the WiFi and Wi-Fi password can not be blank.

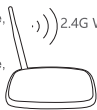

Wi-Fi Router

Green LED indicator status:

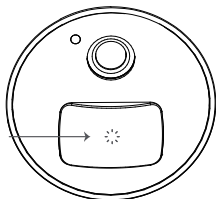

- OFF
No power or WiFi connected

- ON
Device is starting

- ☀ Fast blink
WiFi disconnected

- ☀ Slow blink
Waiting connect to WiFi

Micro SD card user caution

- To ensure SD card video recording works steady, we recommend Class 10 or above version high speed Micro SD card.
- To make sure the device works normally, please format the SD card before the first time use.
- Before insert or pull out the SD card, please power off the device. Insert the SD card properly into the slot as below.

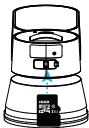

✓ Correct

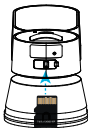

✗ Wrong

2.Operation Instruction (IMPORTANT! please read.)

After installing the Floodlight Cam, turn on the power and wait for about 40 seconds, the device sound the prompt tone three times.

- i** When configuring the device, please put your phone, WiFi router and the device as close as possible, otherwise, it could be failed.

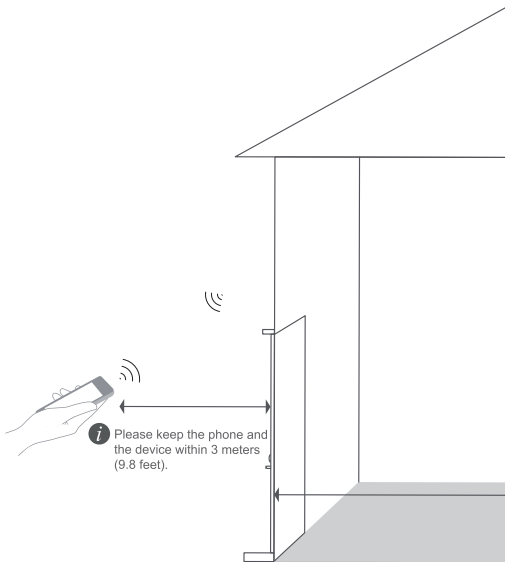

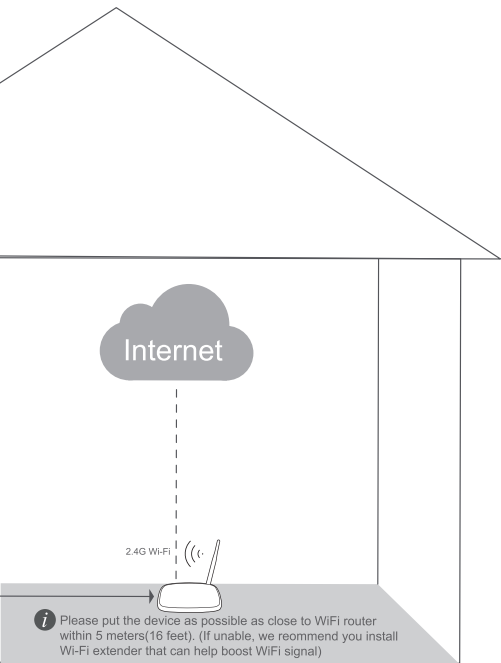

i Please put the device as possible as close to WiFi router within 5 meters(16 feet). (If unable, we reommend you install Wi-Fi extender that can help boost WiFi signal)

3.Configure Device

Open the App

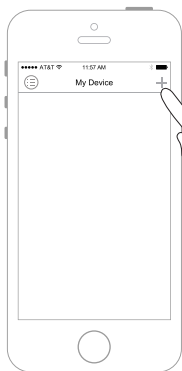

1 Click "+"

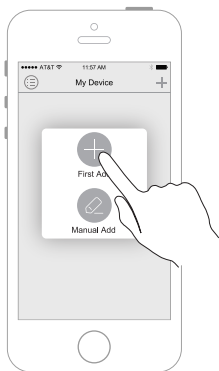
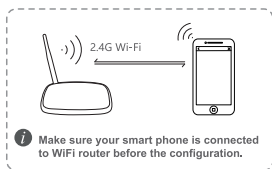

2 Click "First Add"



3 Name the device



4 Scan the QR code on the back housing

Option 1:

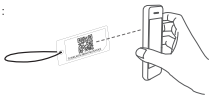

Option 2:

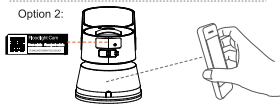

i WARNING

Don't use the Chinese or special symbol to name the WiFi.

Don't use the Chinese or special symbol as the password of WiFi.

- 5** Input the right password of the WiFi



- 6** Please put your smart phone or tablet PC close to the device within 3 m, then press to configure.

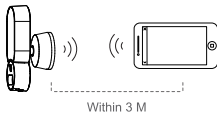
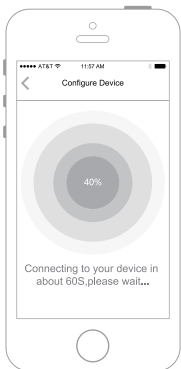

- i** Turn the volume of smart-phone or tablet PC to maximum.

- 7** Wait for about 60 seconds, the configuration will be done.
(After the configuration is successful, the green LED indicator will be off in about 60 seconds.)

i **If configuration failed**

- Please make sure input right password (check the capital&small letter,blank)
- Please keep the distance between the device and the WiFi router within 5m.
- Press and hold [RESET] for 5 seconds, the device is restored to factory default setting, repeat the configuration again.

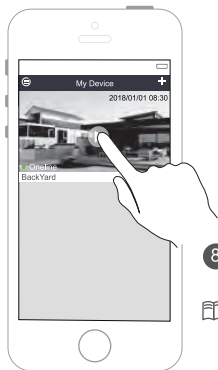
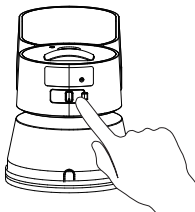
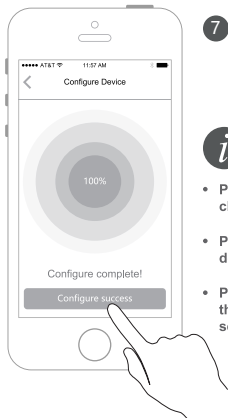

- 8** Click the screen to watch the video.



If the live video is frozen, please close it and open again. If it is still frozen, please power off and restart the device and the WiFi router, keep the device and the WiFi router within 8m to configure again.

4.Watch Video

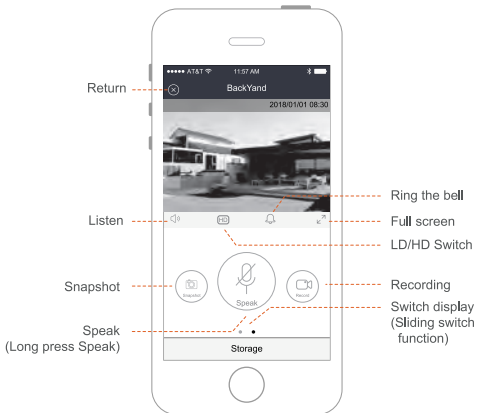

Tips on WIFI Configuration

1. Make sure the device is powered on.
2. Make sure the device is ready to be configured.

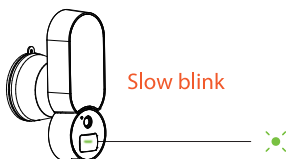

3. Make sure the phone is connected to WiFi, and the volume is the maximum.

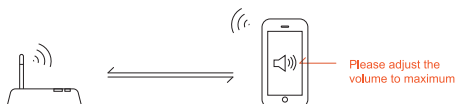

4. Make sure using the 2.4GHz, and the router's DHCP is turned on. (If you don't know how to switch from 5GHz to 2.4GHz, please consult to the service provider of your Wifi router .)



5. Make sure the device, mobile phone, and router are within 5 meters when configuration .



 Make sure that the router's WiFi password is correct and there are no special characters. Such as %\$#@* ect (WiFi password cannot be blank) .

Tips on WIFI Configuration

If failed again, please:

1. After the device is powered on, press and hold the "Reset" button for 5 seconds, reset the device, wait for 40 seconds, hear the sound 3 times.

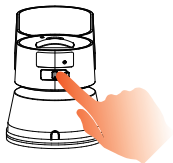

2. Reboot the router.

- i** If you USE "Wi-Fi extender" to configure the device, the App will tell you connection failed, but actually it may succeeded already, you need to follow it as below:

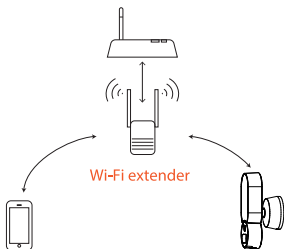

1. Open App, Click "+", then click "Manual Input ID".
2. Input the device UID, you can find the QR code on the backside of the camera, Then input the password and "Save". (Default password is "admin")
3. If still can not connect to Wi-Fi, please contact your vendor.

FAQ

For more questions, please refer to FAQ list in Our APP

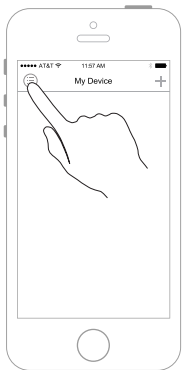

1 Open the App, then click "☰"

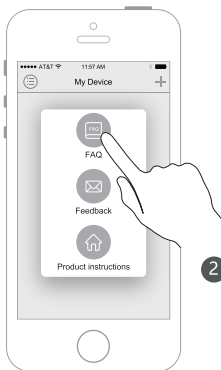

2 Click "FAQ" enter FAQ page



FCC Statement

Changes or modifications not expressly approved by the party responsible for compliance could void the user's authority to operate the equipment.

This equipment has been tested and found to comply with the limits for a Class B digital device, pursuant to Part 15 of the FCC Rules.

These limits are designed to provide reasonable protection against harmful interference in a residential installation.

This equipment generates uses and can radiate radio frequency energy and, if not installed and used in accordance with the instructions, may cause harmful interference to radio communications.

However, there is no guarantee that interference will not occur in a particular installation.

If this equipment does cause harmful interference to radio or television reception, which can be determined by turning the equipment off and on, the user is encouraged to try to correct the interference by one or more of the following measures:

- Reorient or relocate the receiving antenna.
- Increase the separation between the equipment and receiver.
- Connect the equipment into an outlet on a circuit different from that to which the receiver is connected.
- Consult the dealer or an experienced radio/TV technician for help.

This device complies with part 15 of the FCC rules. Operation is subject to the following two conditions (1) this device may not cause harmful interference, and (2) this device must accept any interference received, including interference that may cause undesired operation.

ATTENTION!



If you see any water vapour inside the camera screen or the LED light glass, pls you can take off the cover of the SD slot until the vapor disappeared.

About the User Manual:

The user manual is used as a guide.

The photos, graphic, charts and illustrations provided in the user Manual are only used to explanation and interpretation, which may be different from specific products, please refer to the real object.

The user manual maybe updated because of the products version upgrade or other requirements, if you need the latest version of the user manual, please contact customer service for the latest version of the user manual.